

42-0720 Electrical test program - Model 124 (except 124.034), 201

Operation no. of operation texts and work units or standard texts
and flat rates:
42-0025.

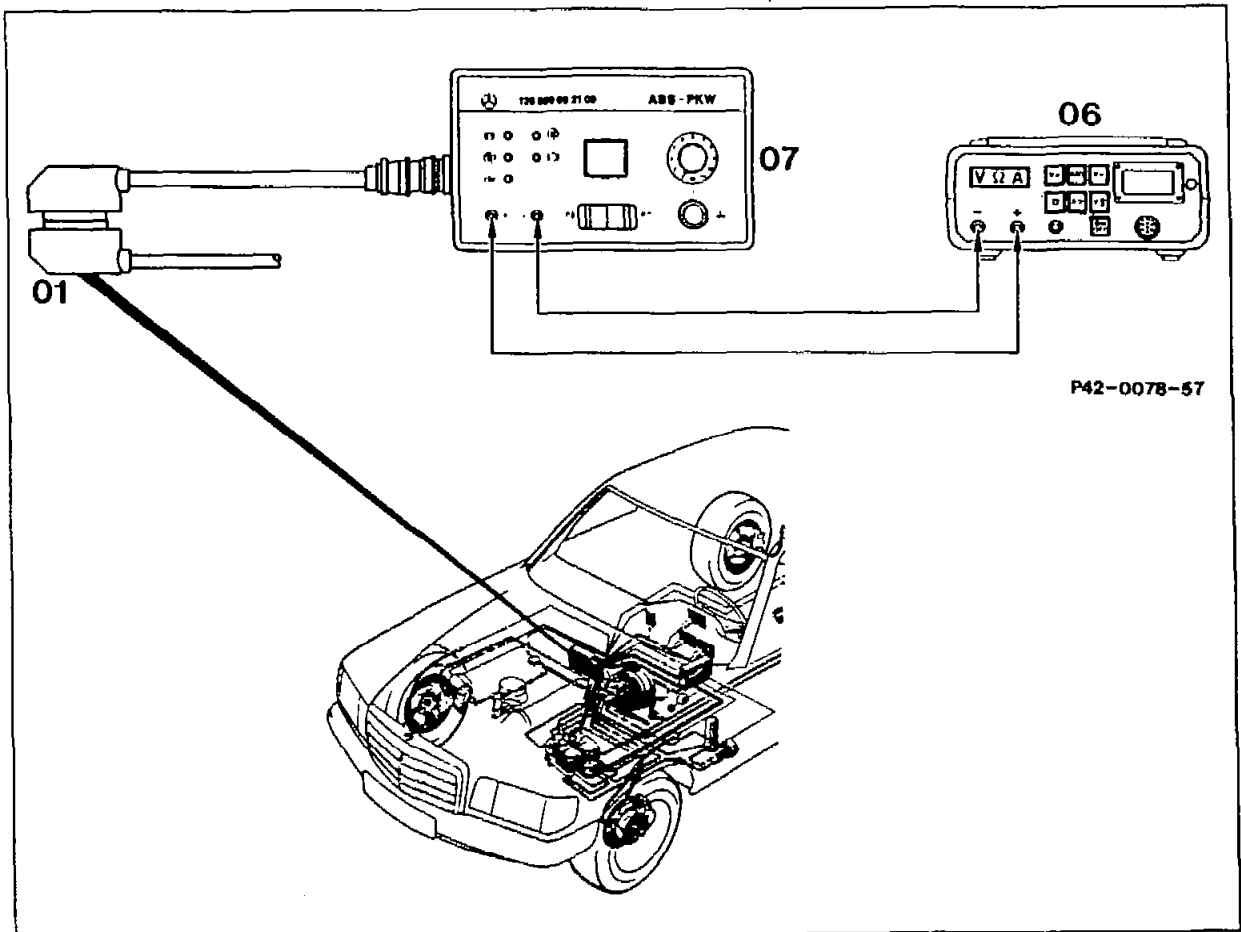

- 01 Connector - ABS control unit (N30)
- 06 Multimeter
- 07 ABS adapter

Connection diagram

With the ignition switched off, detach connector from ABS control unit (N30) and connect to the adapter. Connect multimeter (06) to ABS adapter (07).

Special tools

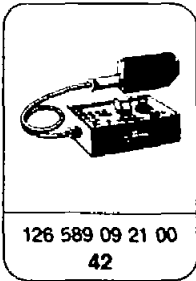

Commercially available tool or tester

Designation	e.g. Company, order no.
Multimeter	Sun, DMM-5

Complaint-related troubleshooting chart

Complaint	Possible cause	Remedy Description of diagnosis Test step/adapter position
Pulsating pedal under light braking, shortly before vehicle stops	Wheel speed sensor voltage too low	8/4-13/6, 17/4, 20/5, 23/6
ABS malfunction indicator lamp comes on and remains on during vehicle operation	Wheel speed sensor cable interrupt	8/4-13/6, 17/4, 20/5, 23/6
ABS malfunction indicator lamp comes on sporadically during vehicle operation	System voltage < 11 V, too many electrical ancillaries in use	3/1
ABS malfunction indicator lamp on, charge indicator lamp off	Defective alternator (1 diode)	Check alternator
ABS malfunction indicator lamp and charge indicator lamp on	Defective alternator (2 diodes)	Check alternator
Model 124 4MATIC ABS malfunction indicator lamp comes on during vehicle operation and remains on until ignition is switched off	Open circuit Wheel-speed sensor	Perform electric/electronic test program for 4MATIC

Complaint-related troubleshooting chart

Complaint	Possible cause	Remedy Description of diagnosis Test step/adapter position
ABS malfunction indicator lamp fails to go out when engine is started	ABS control unit (N30) connector not connected. Plug connection has bad contact. Overvoltage protection relay defective.	1/1, 3/1
ABS malfunction indicator lamp does not go out when engine is started	Diode in solenoid valve relay defective	7/3
Return pump runs when ignition key is removed	Return pump relay (A7k2) sticks	Replace relay (A7k2)

Notes on adapter

Using this tester the complete ABS system can be checked with the exception of the electronic control unit.

Test conditions

For all test procedures with ignition **ON**: the  LED must light up to indicate adequate battery voltage, and all other electrical equipment must be switched off.



Never drive the vehicle when the ABS adapter (07) is connected.

Model 129

Before connecting, unscrew lock on plug of the ABS adapter 126 589 09 21 00.

The test and diagnosis instructions for models 124.034, 129 and 140 are described in the diagnosis manual - chassis volume 2.

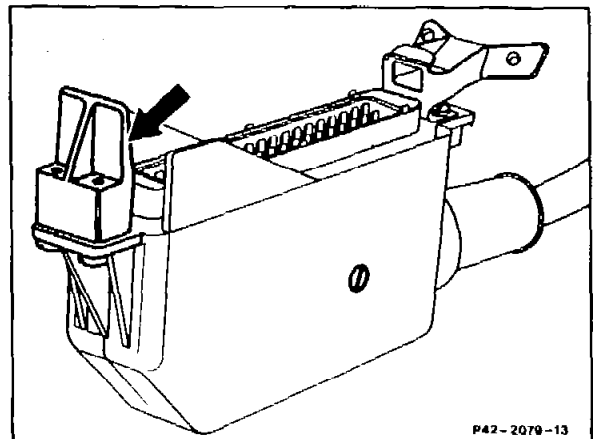

























P42-2079-13



















Test program

Test step/ adapter pos.	Scope of test	Measuring equipment/ test connection	Operation/ requirement	Nominal value	Possible cause/remedy
1/1	Overvoltage protection relay (K1/1)	-	Ignition: OFF	LED: All: OFF	Replace overvoltage protection relay (K1/1) (figure 3-5)
2/1	Solenoid valve relay (A7k1)	-	Ignition: OFF	LED: All: OFF	Replace solenoid valve relay (A7k1) (figure 1)
3/1	Overvoltage protection relay (K1/1)	 to ABS adapter	Ignition: ON	11-14 V LED: Ⓡ: ON Ⓢ: ON ABS malfunction indicator lamp: ON	Battery state of charge incorrect. Replace overvoltage protection relay fuse. Replace overvoltage protection relay. Cable to N30 control unit jack 1 interrupted. Poor contact at plug connec- tion on overvoltage protection. Replace solenoid valve relay (A7k1). Replace ABS malfunction indicator lamp (A1e17).
4/1	Alternator terminal 61	-	Engine: allow to run briefly	LED: Ⓢ: OFF	Connection cables interrupted, alternator defective.
5/1	Stop lamp switch (S9/1)	-	Ignition: ON Operate brake pedal	LED: Ⓢ: ON	Connector makes bad contact. Replace stop lamp switch (S9/1).

Test step/ adapter pos.	Scope of test	Measuring equipment/ test connection	Operation/ requirement	Nominal value	Possible cause/remedy
6/2	Solenoid valve relay (A7k1)	---	Ignition: ON	LED: E±: ON Ⓞ: ON Ⓢ: ON ABS malfunction indicator lamp: OFF	Connection cables interrupted. Replace solenoid valve relay (A7k1) (figure 1).
7/3	Diode in solenoid valve relay (A7k1) or in plug socket of hydraulic unit	←Ⓢ→ to ABS adapter	Ignition: ON	0.4–1.5 V E±: ON Ⓞ: ON	Replace solenoid valve relay (A7k1) or up to 1/86 the hydraulic unit (figure 1).
8/4	Internal resistance Front left wheel-speed sensor (L6/1)	←Ⓢ→ to ABS adapter	Ignition: ON	0.85–2.3 kΩ	Plug connections make bad contact (figure 11). Connection leads interrupted. Replace wheel speed sensor (L6/1) (figure 7).
9/4	Insulation resistance Front left wheel-speed sensor (L6/1)	←Ⓢ→ to ABS adapter	Ignition: ON Press button ⊥	> 20 kΩ	Plug connections make bad contact (figure 11). Replace wheel speed sensor (L6/1) (figure 7).
10/5	Internal resistance Front right wheel-speed sensor (L6/2)	←Ⓢ→ to ABS adapter	Ignition: ON	0.85–2.3 KΩ	Plug connections make bad contact (figure 11). Connection leads interrupted. Replace wheel speed sensor (L6/2) (as figure 7).

Test step/ adapter pos.	Scope of test	Measuring equipment/ test connection	Operation/ requirement	Nominal value	Possible cause/remedy
11/5	Insulation resistance Front right wheel-speed sensor (L6/2)	 to ABS adapter	Ignition: ON Press button \perp	> 20 k Ω	Plug connections make bad contact (figure 11). Replace wheel speed sensor (L6/2).
12/6	Internal resistance Rear-axle wheel-speed sensor	 to ABS adapter	Ignition: ON	0.6–1.6 K Ω	Plug connection makes bad contact (figure 12). Replace wheel speed sensor (L6) (figure 8).
13/6	Insulation resistance Rear-axle wheel-speed sensor (L6)	 to ABS adapter	Ignition: ON Press button \perp	> 20 k Ω	Plug connection makes bad contact (figure 12). Replace wheel speed sensor (L6) (figure 8).
14/8	Internal resistance Left front solenoid valve (A7y1)	 to ABS adapter	Ignition: OFF Press button \perp	0.7–2.2 Ω	Connector on hydraulic unit (A7) makes bad contact (figure 1). Connection leads interrupted. Replace hydraulic unit (A7).
15/9	Internal resistance Right front solenoid valve (A7y2)	 to ABS adapter	Ignition: OFF Press button \perp	0.7–2.2 Ω	Connector on hydraulic unit (A7) makes bad contact (figure 1). Connection leads interrupted. Replace hydraulic unit.
16/10	Internal resistance Rear-axle solenoid valve (A7y3)	 to ABS adapter	Ignition: OFF Press button \perp	0.7–2.2 Ω	Connector on hydraulic unit (A7) makes bad contact (figure 1). Connection leads interrupted. Replace hydraulic unit.

Test step/ adapter pos.	Scope of test	Measuring equipment/ test connection	Operation/ requirement	Nominal value	Possible cause/remedy
17/4	Check voltage at left front wheel-speed sensor (L6/1)	 to ABS adapter	Ignition: ON Turn left front wheel (approx. 1/s)	≥ 0.1 V~	Wheel bearing play excessive. Plug connection makes bad contact (figure 11). Connection leads interrupted or interchanged. Replace wheel speed sensor (L6/1).
18/8	Left front solenoid valve (A7y1) Pressure retention	 remains connected	Ignition: ON Turn left front wheel (approx. 1/s) Press switch: P = Operate brake pedal	LED:  : ON  : ON  : ON  : ON Wheel must be able to turn	Ground (14) makes bad contact (figure 9). Brake lines to hydraulic unit (A7) interchanged (figure 10). Connection leads interchanged. Replace hydraulic unit (A7).
19/8	Left front solenoid valve (A7y1) Pressure bleed	 remains connected	Ignition: ON Operate brake pedal Press switch: P ↓ Turn left front wheel (approx. 1/s)	LED:  : ON  : ON  : ON  : ON  : ON Wheel must be able to turn	Ground (14) makes bad contact (figure 9). Replace return pump relay (A7k2) (figure 1). Replace hydraulic unit (A7).
20/5	Check voltage at right front wheel-speed sensor (L6/2)	 to ABS adapter	Ignition: ON Turn right front wheel (approx. 1/s)	≥ 0.1 V~	Wheel bearing play excessive. Plug connection makes bad contact. Connection leads interrupted or interchanged. Replace wheel speed sensor (L6/2).
21/9	Right front solenoid valve (A7y2) Pressure retention	 remains connected	Ignition: ON Turn right front wheel (approx. 1/s) Press switch: P = Operate brake pedal	LED:  : ON  : ON  : ON  : ON Wheel must be able to turn	Ground (14) makes bad contact (figure 9). Brake lines to hydraulic unit interchanged. Connection leads interchanged (figure 10). Replace hydraulic unit (A7).

Test step/ adapter pos.	Scope of test	Measuring equipment/ test connection	Operation/ requirement	Nominal value	Possible cause/remedy
22/9	Right front solenoid valve (A7y2) Pressure bleed	 remains connected	Ignition: ON Operate brake pedal Press switch: P ↓ Turn right front wheel (approx. 1/s)	LED:  : ON  : ON  : ON  : ON  : ON Wheel must be able to turn	Ground (14) makes bad contact (figure 9). Replace return pump relay (A7k2). Replace hydraulic unit (A7).
23/6	Check voltage at rear-axle wheel-speed sensor (L6)	 to ABS adapter	Ignition: ON Turn one rear wheel (approx. 1/s) 1)	≥ 0.1 V~	Wheel speed sensor contaminated. Plug connection makes bad contact (figure 12). Connection leads interrupted. Replace wheel speed sensor (L6).
24/10	Rear-axle solenoid valve (A7y3) Pressure retention	 remains connected	Ignition: ON Turn one rear wheel (approx. 1/s) 1) Press switch: P = Operate brake pedal	LED:  : ON  : ON  : ON  : ON Wheel must be able to turn	Ground (14) makes bad contact (figure 9). Brake lines to hydraulic unit interchanged. Connection leads interchanged (figure 10). Replace hydraulic unit (A7).
25/10	Rear-axle solenoid valve (A7y3) Pressure bleed	 remains connected	Ignition: ON Operate brake pedal Press switch: P ↓ Turn one rear wheel (approx. 1/s) 1)	LED:  : ON  : ON  : ON  : ON  : ON Wheel must be able to turn	Ground (14) makes bad contact (figure 9). Replace return pump relay (A7k2) (figure 1). Replace hydraulic unit (A7).

1) When turning one wheel make sure that the other wheel does not turn at the same time.

Figure 1

A7K1 Solenoid valve relay
A7K2 Return pump relay

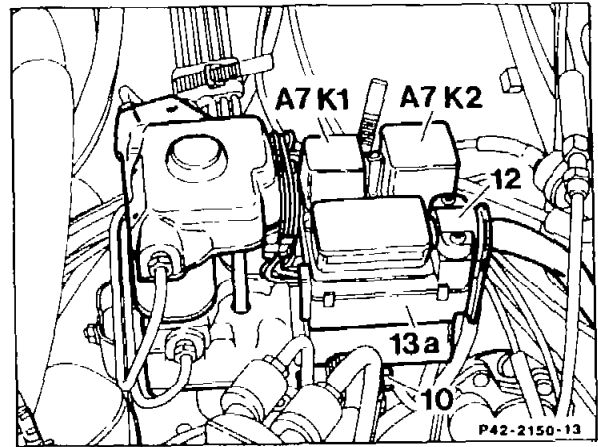

Figure 2

N30 Control unit (example model 124)

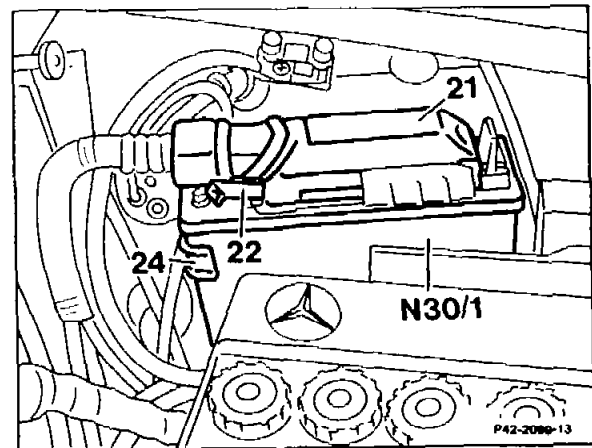

Figure 3

K1/1 Overvoltage protection model 124

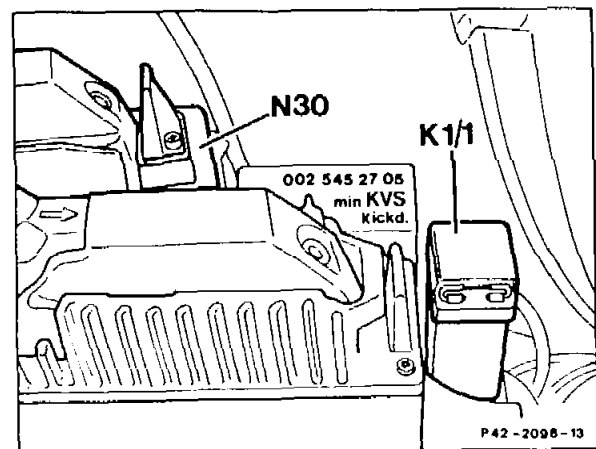

Figure 4

K1/1 Overvoltage protection model 201 up to 12/84

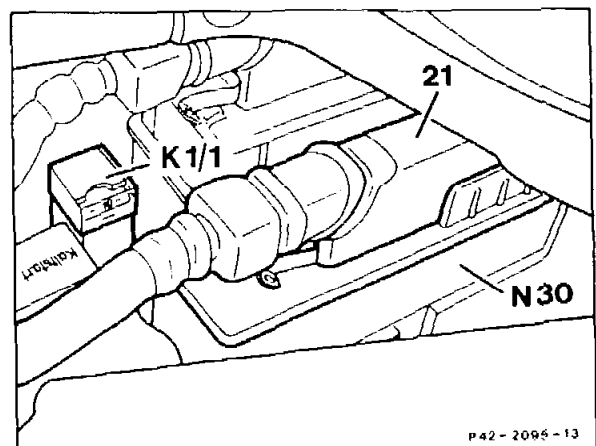

Figure 5

K1/1 Overvoltage protection model 201 as of 01/85

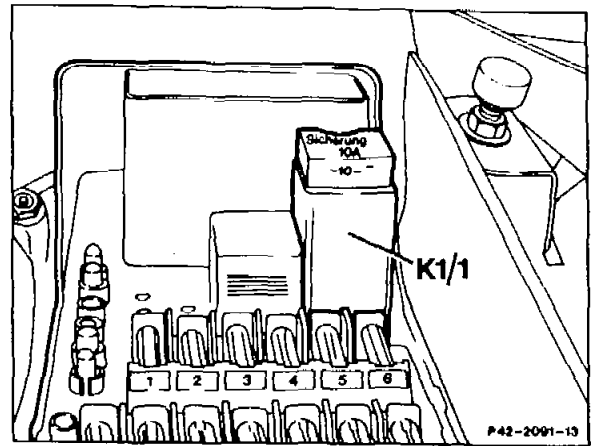

Figure 6

- A Hydraulic unit as of 01/86
- B Hydraulic unit up to 12/85 with integrated diode in plug socket

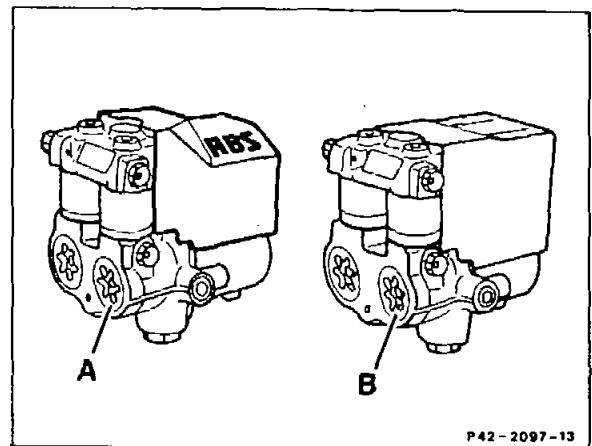

Figure 7

- L6/1 Left front wheel speed sensor
- L6/2 Right front wheel speed sensor

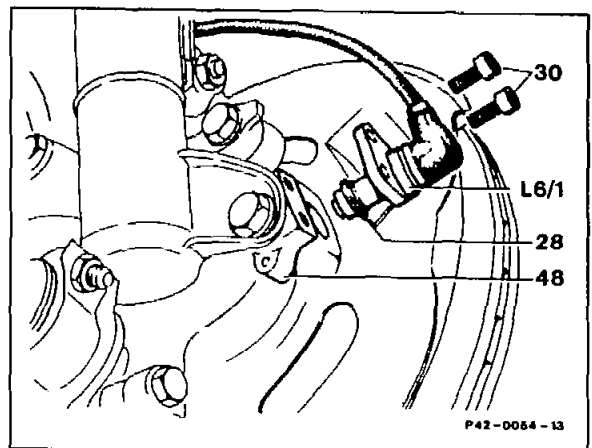

Figure 8
L6 Rear axle speed sensor

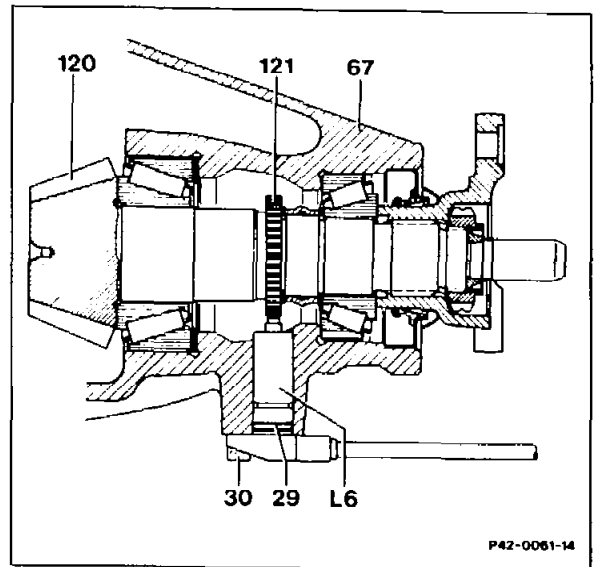

Figure 9
14 Ground connection on socket of hydraulic unit

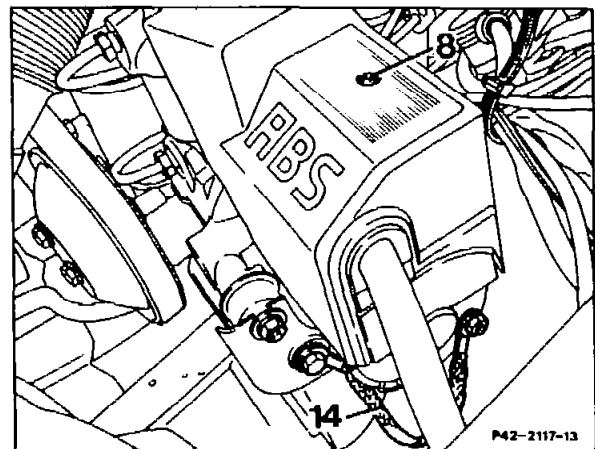

Figure 10
2 Tandem brake master cylinder to front axle brake circuit (V)
3 Tandem brake master cylinder to rear axle brake circuit (H)
4 Hydraulic unit to front axle right (r)
5 Hydraulic unit to front axle left (l)
6 Hydraulic unit to rear axle (h)

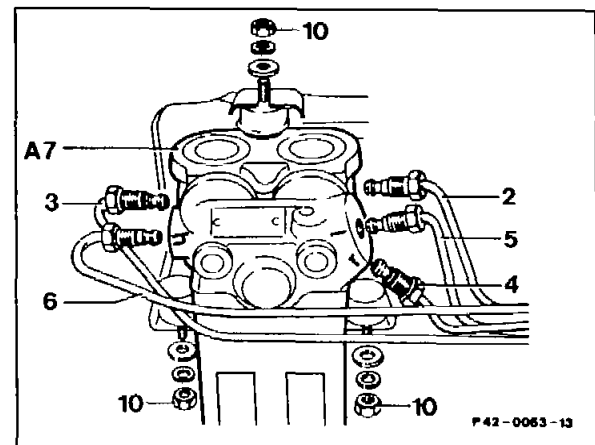

Figure 11
L6/2x Plug connector - Right front wheel-speed sensor
(L6/1x installed symmetrically)

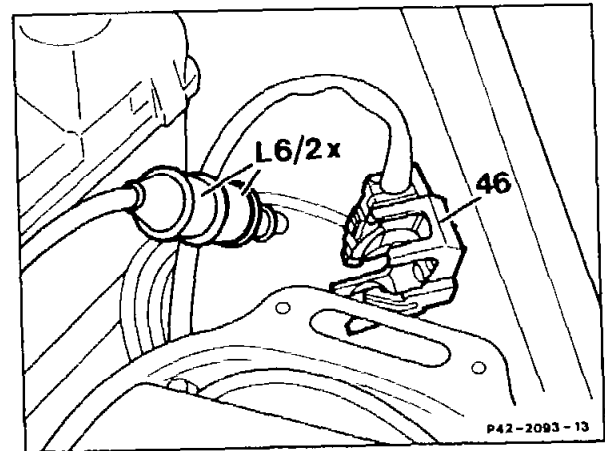

Figure 12
L6x1 Cable connection - rear axle

